

**CC N** CONICAL CONNECTOR N

Series	
KN22	



**PN** PIN N

Series	
KN22	

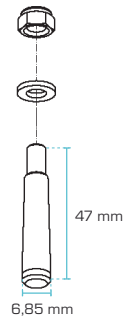

**PN M6** PIN N WITH THREAD M6

Series	supplied with washer and nylock nut
KN22	

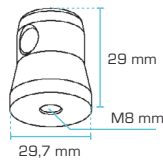

**CC N M8** HALF CONNECTOR N WITH THREAD M8

Series	screw fixing not included, please order separately if required
KN22	



**SRP M** SAFETY R CLIP M

Series	
M222	

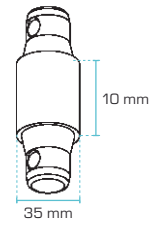

**CC ND10** SPACER N 10 mm

Series	
KN22	

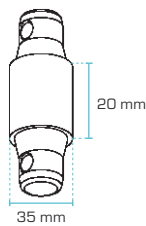

**CC ND20** SPACER N 20 mm

Series	
KN22	

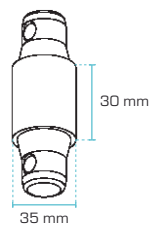

**CC ND30** SPACER N 30 mm

Series	
KN22	

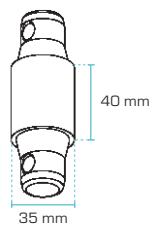

**CC ND40** SPACER N 40 mm

Series	
KN22	

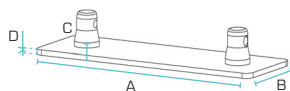

**2KN-22-BP**  
**2KN-22-WP** BASE/WALL PLATE 2KN-22 WITH HALF CONNECTORS

Series	A	B	C	D	
KN22	270	90	10	5	mm

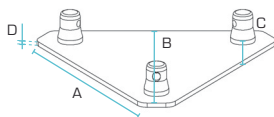

**3KN-22-BP**  
**3KN-22-WP** BASE/WALL PLATE 3KN-22 WITH HALF CONNECTORS

Series	A	B	C	D	
KN22	262	230	10	5	mm

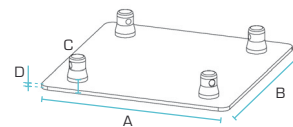

**4KN-22-BP**  
**4KN-22-WP** BASE/WALL PLATE 4KN-22 WITH HALF CONNECTORS

Series	A	B	C	D	
KN22	270	270	10	5	mm

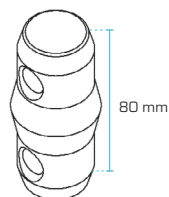

**CC U** CONICAL CONNECTOR B

Series	
K30/KH30	
K40/KH40	

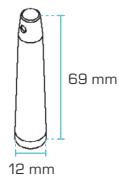

**PB** PIN B

Series	
K30/KH30	
K40/KH40	

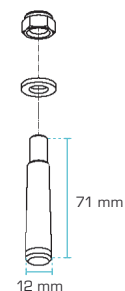

**PB M8** PIN B WITH THREAD M8

Series	
K30/KH30	supplied with washer and nylock nut
K40/KH40	

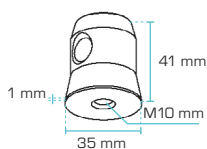

**CC U M10** HALF CONNECTOR B WITH THREAD M10

Series	
K30/KH30	screw fixing not included, please order separately if required
K40/KH40	

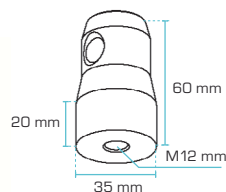

**CC U M12** HALF CONNECTOR B WITH THREAD M12

Series	
K30/KH30	screw fixing not included, please order separately if required
K40/KH40	

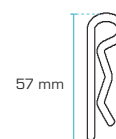

**SRP B** SAFETY R CLIP B

Series	
K30/KH30	supplied with washer and nylock nut
K40/KH40	

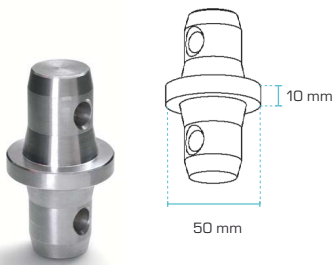

**CC UD10** SPACER U 10 mm

Series	
K30 /KH30	
K40 /KH40	



**CC UD20** SPACER U 20 mm

Series	
K30 /KH30	
K40 /KH40	



**CC UD30** SPACER U 30 mm

Series	
K30 /KH30	
K40 /KH40	



**CC UD40** SPACER U 40 mm

Series	
K30 /KH30	
K40 /KH40	



**HINGE PART**

Series	
K30 /KH30	
K40 /KH40	



**CF U D105** CONICAL FEMALE U 105 mm

Series	
K30 /KH30	
K40 /KH40	

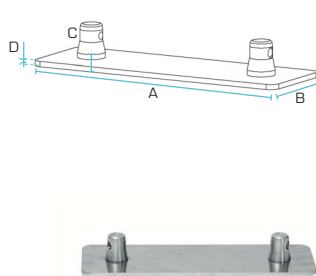

**2K-30-BP** BASE /WALL PLATE 2K30 WITH HALF CONNECTORS  
**2K-30-WP**

Series	A	B	C	D	
K30 /KH30	350	110	10	5	mm

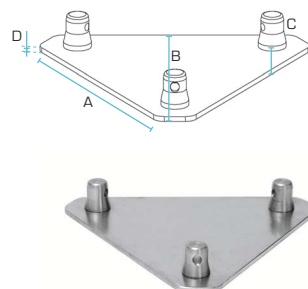

**3K-30-BP** BASE /WALL PLATE 3K30 WITH HALF CONNECTORS  
**3K-30-WP**

Series	A	B	C	D	
K30 /KH30	346	303	10	5	mm

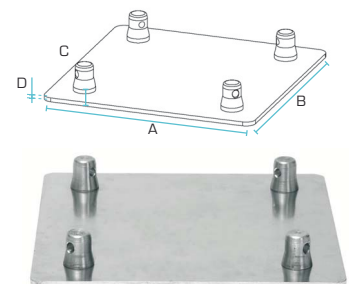

**4K-30-BP** BASE /WALL PLATE 4K30 WITH HALF CONNECTORS  
**4K-30-WP**

Series	A	B	C	D	
K30 /KH30	350	350	10	5	mm

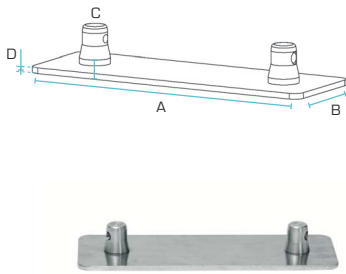

**2K-40-BP**  
**2K-40-WP** BASE/WALL PLATE 2K40 WITH HALF CONNECTORS

Series	A	B	C	D	
K40/KH40	450	110	10	5	mm

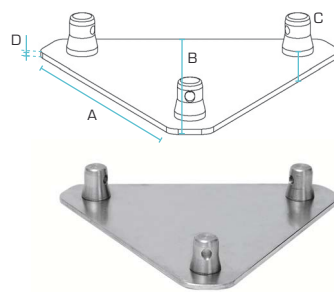

**3K-40-BP**  
**3K-40-WP** BASE/WALL PLATE 3K40 WITH HALF CONNECTORS

Series	A	B	C	D	
K40/KH40	442	385	10	5	mm

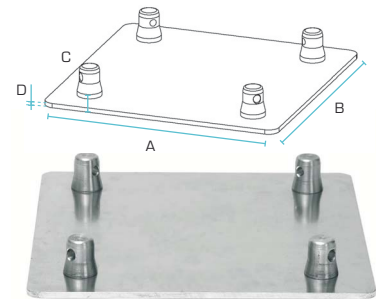

**4K-40-BP**  
**4K-40-WP** BASE/WALL PLATE 4K40 WITH HALF CONNECTORS

Series	A	B	C	D	
K40/KH40	450	450	10	5	mm

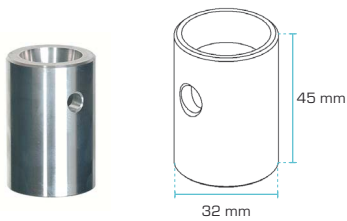

**CON 46N** FEMALE FITTING FOR MULTICUBE KN-22 MC

Series	
KN22	



**CON 25U** FEMALE FITTING FOR MULTICUBE KH-30 MC/KH-40 MC

Series	
K30/KH30/K40/KH40	



**SRP O** SAFETY R CLIP O

Series	
4GS 35/4GS 50/4GS 62/4GS 62F/4GX 91	



**PGS** PIN GS

Series	
4GS 35/4GS 50/4GS 62/4GS 62F	

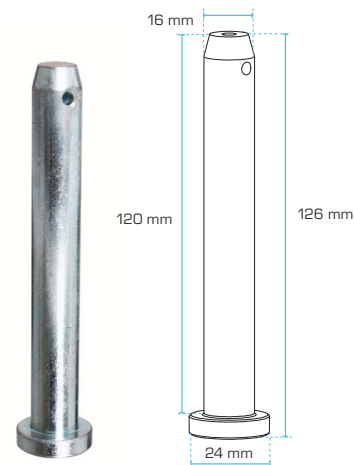

**PGSF** PIN GS FOLDING

Series	
4GS 62F	



**PGX** PIN GX

Series	
4GX 91	



**CON 01U/A** HOOK EXTENSION LONG  
FOR TUBE 48-51 mm

Series  
K30 / KH30 / K40 / KH 40

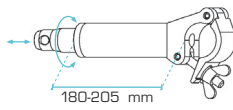

**CON 02U/A** HOOK EXTENSION SHORT  
FOR TUBE 48-51 mm

Series  
K30 / KH30 / K40 / KH 40

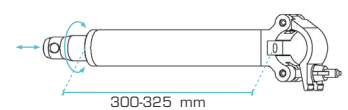

**CON 03U** HAND EXTENSION LONG  
FOR TUBE 48-51 mm

Series  
K30 / KH30 / K40 / KH 40

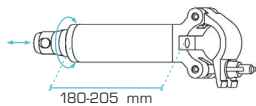

**CON 04U** HAND EXTENSION SHORT  
FOR TUBE 48-51 mm

Series  
K30 / KH30 / K40 / KH 40

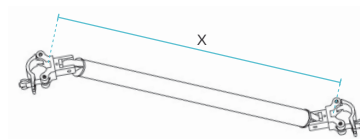

**CB D50** CORNER BRACE  
VARIOUS LENGTHS

Series  
K30 / KH30 / K40 / KH 40

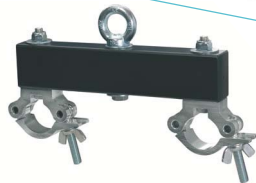
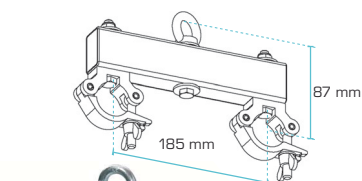

**CS3-KN-22** CEILING SUPPORT  
FOR KN22 SYSTEM

Series SWL 200 kg  
KN22

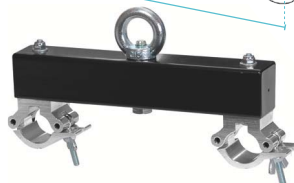
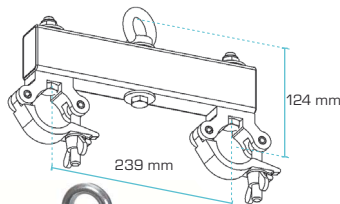

**CS3-K-30** CEILING SUPPORT  
FOR K30 / KH30 SYSTEM

Series SWL 500 kg  
K30 / KH30

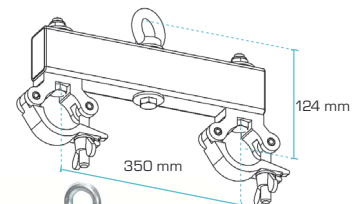

**CS3-K-40** CEILING SUPPORT  
FOR K40 / KH 40 SYSTEM

Series SWL 500 kg  
K40 / KH 40